



CATALOGUE

NHÔM NỘI THẤT HỆ TỦ CẢNH KÍNH

*ALUMINIUM FOR FURNITURE
GLASS DOOR CABINET*

THƯ NGỎ OPEN LETTER

Kính gửi Quý Khách hàng và đối tác,

Công ty TNHH Nhôm định hình Sapa Bến Thành (Sapa BTG) chân thành cảm ơn Quý khách hàng đã luôn tin tưởng và đồng hành cùng chúng tôi.

Được thành lập từ năm 1996, Sapa BTG có 30 năm kinh nghiệm trên thị trường, chuyên sản xuất và cung cấp sản phẩm nhôm định hình chất lượng cao, đáp ứng theo các tiêu chuẩn quốc tế (như JIS, ASTM, EN, AS/NZS, AA, ISO...).

Sản phẩm được sử dụng phôi nhôm chính phẩm, xử lý bề mặt cao cấp bằng công nghệ hiện đại và gia công cơ khí hoàn chỉnh, nên ứng dụng rộng rãi trong hầu hết các lĩnh vực, từ kiến trúc xây dựng, trang trí nội thất, gia dụng đến các ngành công nghiệp đòi hỏi kỹ thuật cao như cơ khí, điện, điện tử, vận tải, ô tô, đóng tàu, năng lượng (mặt trời và gió).

Quan điểm kinh doanh được xây dựng dựa trên mối quan hệ mật thiết với khách hàng và đặt chất lượng lên hàng đầu. Đây là nền tảng giúp Sapa BTG trở thành đối tác chiến lược và nhà cung cấp uy tín của nhiều doanh nghiệp lớn trong và ngoài nước. Chúng tôi tin rằng với năng lực và kinh nghiệm chuyên sâu, Sapa BTG sẽ giúp quý khách hàng tối ưu hóa chi phí thông qua những giải pháp kỹ thuật hợp lý.

Sapa BTG mong muốn trở thành đối tác chiến lược đồng hành và đóng góp vào sự phát triển bền vững của Quý khách hàng.

Trân trọng,

Sapa BTG.

Dear valued customers and partners,

Sapa Ben Thanh Extrusion Co., Ltd. (Sapa BTG) wishes to extend its sincere gratitude for your consistent trust and partnership.

Established in 1996, Sapa BTG now stands on three decades of proven experience in the market. We are dedicated to manufacturing and supplying the high-quality aluminium extrusion product, compliant to the international standards (including JIS, ASTM, EN, AS/NZS, AA, ISO, etc.).

Our products are extruded from the primary aluminum billet, featuring advanced surface treatment technologies and the meticulous mechanical machining. This ensures their wide application across diverse sectors: Architecture & Construction, Interior and External Furniture, and Household Goods, as well as highly demanding industrial fields such as Mechanical, Electrical, Electronics, Transportation, Automotive, Shipbuilding, and Renewable Energy (Solar and Wind).

Our business motto is based on close relationships with customers and the dedication to quality excellence. This foundation has established Sapa BTG as a strategic partner and trusted supplier to many leading companies, both locally and globally. We are confident that our in-depth expertise and operational capacity will assist you in achieving the cost-efficiency via practical engineering solutions.

Sapa BTG looks forward to serving as your trusted strategic partner, actively contributing to your success and sustainable growth for years to come.

Sincerely,

Sapa BTG.

TỦ NHÔM CÁNH KÍNH TAY NẮM CNC
SLIM S68

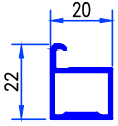

6874

W = 0.273 kg/m
T = 1.2 mm

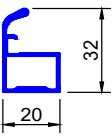

6873

W = 0.350 kg/m
T = 1.2 mm

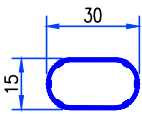

6852

W = 0.208 kg/m
T = 1.0 mm

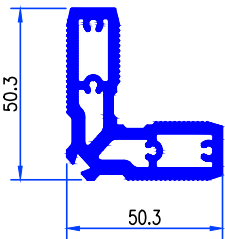

7186

W = 1.982 kg/m
T = 17.0 mm

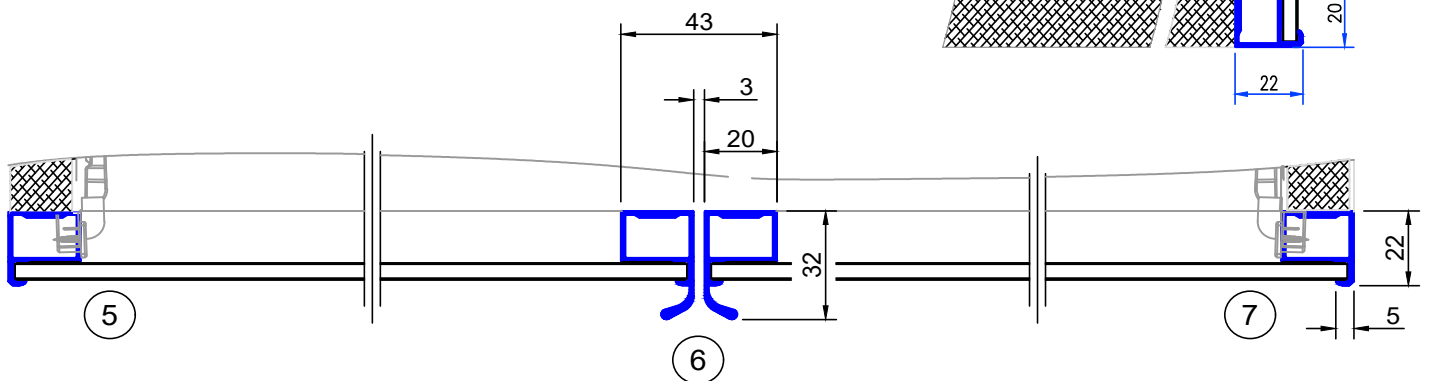
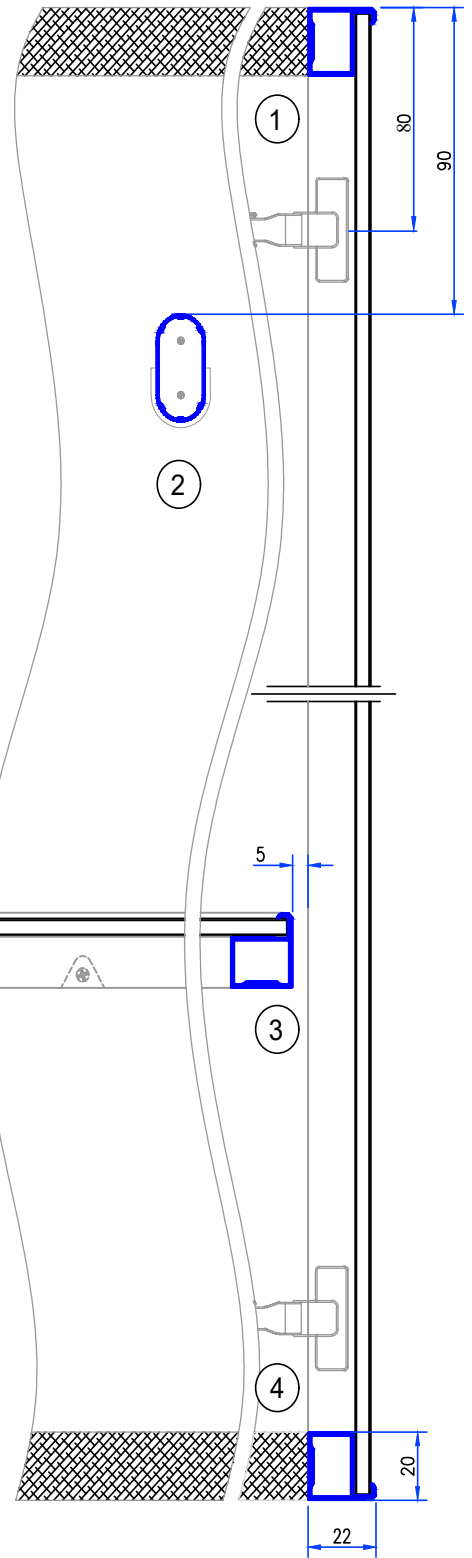
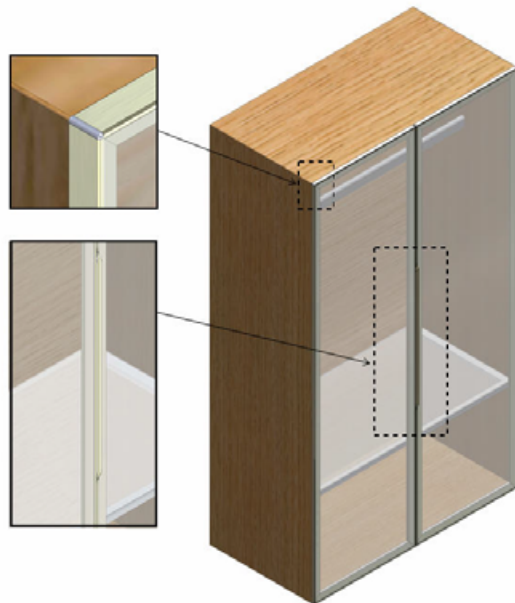
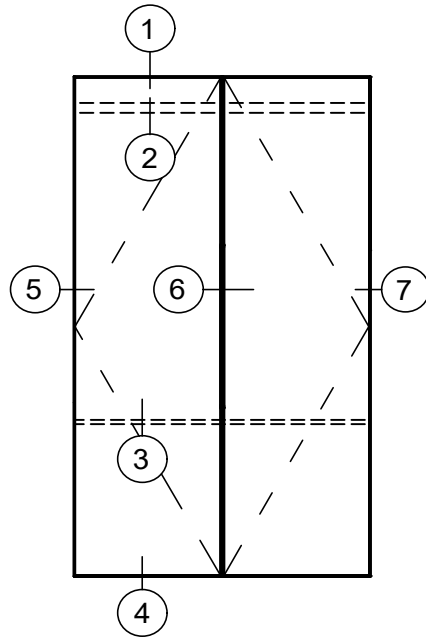

TỦ NHÔM CÁNH KÍNH TAY NẮM ÂM
SLIM S68

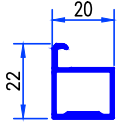

6874

W = 0.273 kg/m
T = 1.2 mm

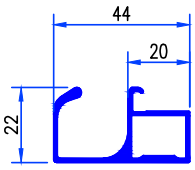

7662

W = 0.498 kg/m
T = 1.2 mm

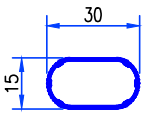

6852

W = 0.208 kg/m
T = 1.0 mm

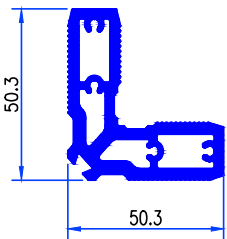

7186

W = 1.982 kg/m
T = 17.0 mm

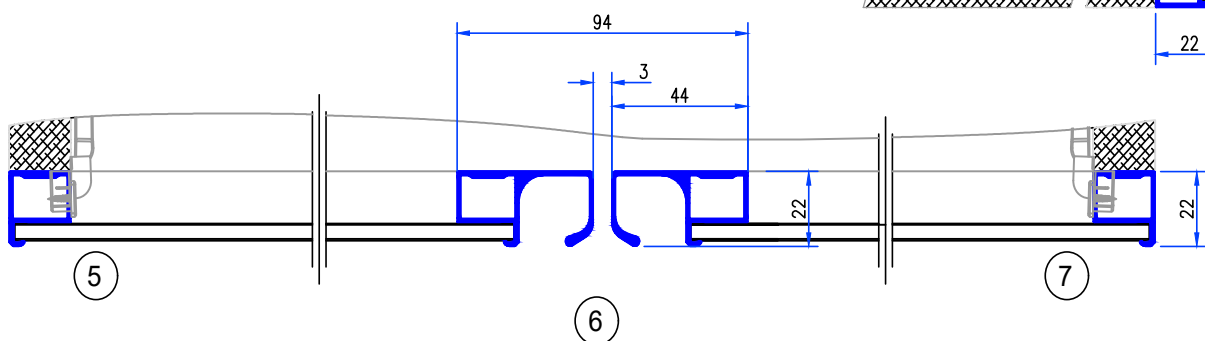
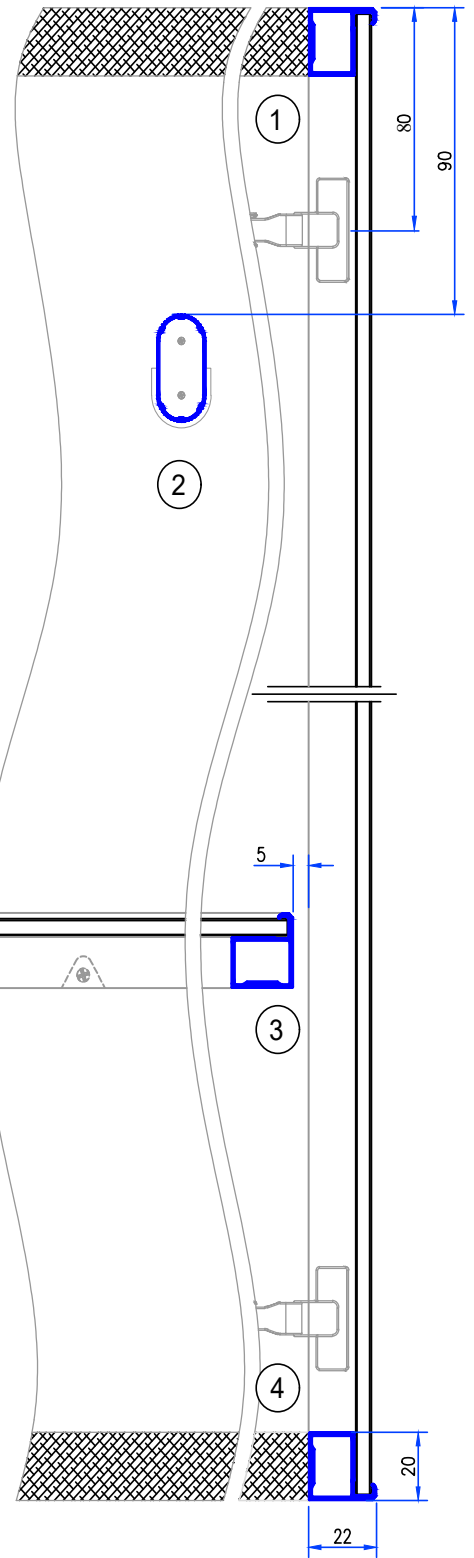
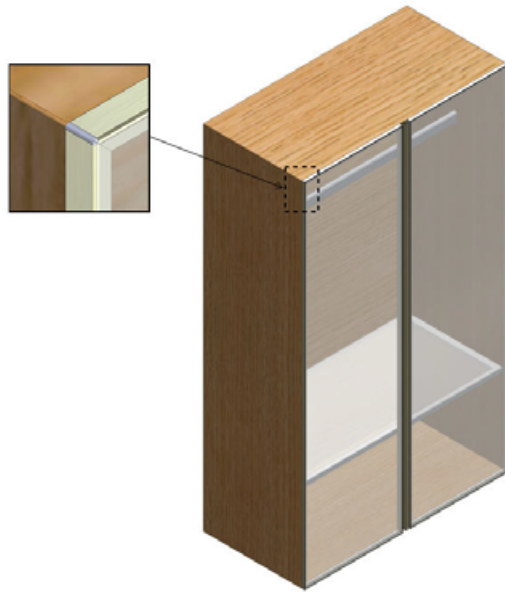
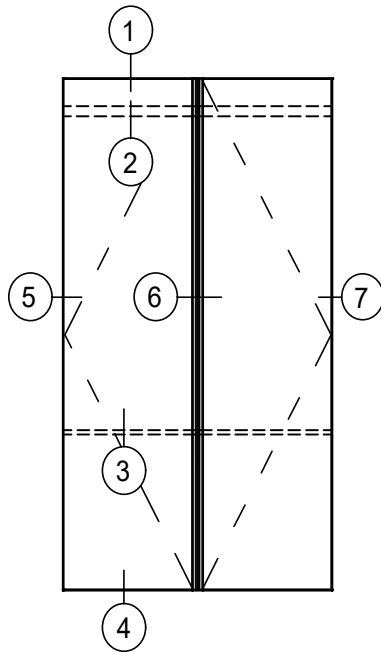

TỦ NHÔM CÁNH KÍNH TAY NẮM U CNC
SLIM S68

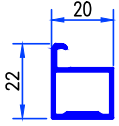

6874

W = 0.273 kg/m
T = 1.2 mm

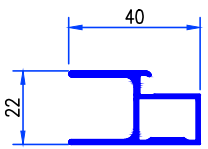

7663

W = 0.467 kg/m
T = 1.2 mm

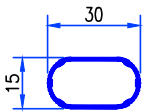

6852

W = 0.208 kg/m
T = 1.0 mm

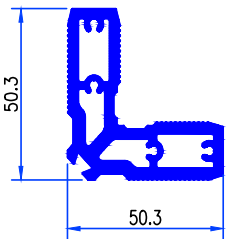

7186

W = 1.982 kg/m
T = 17.0 mm

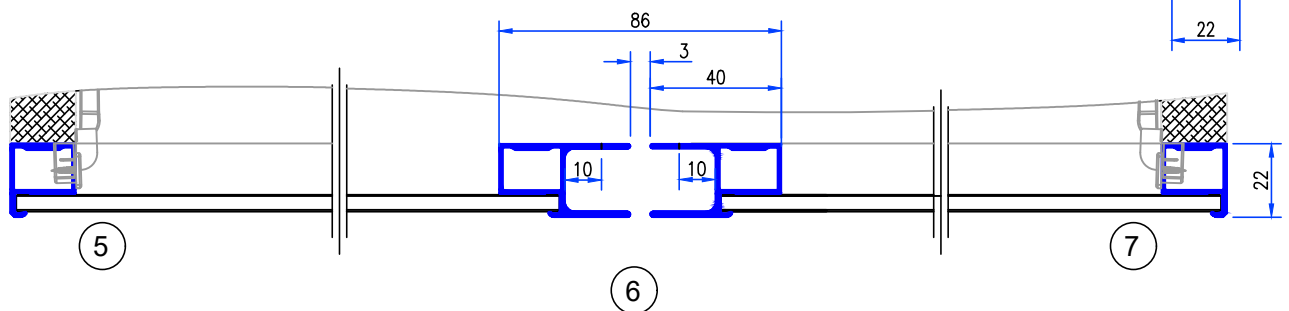
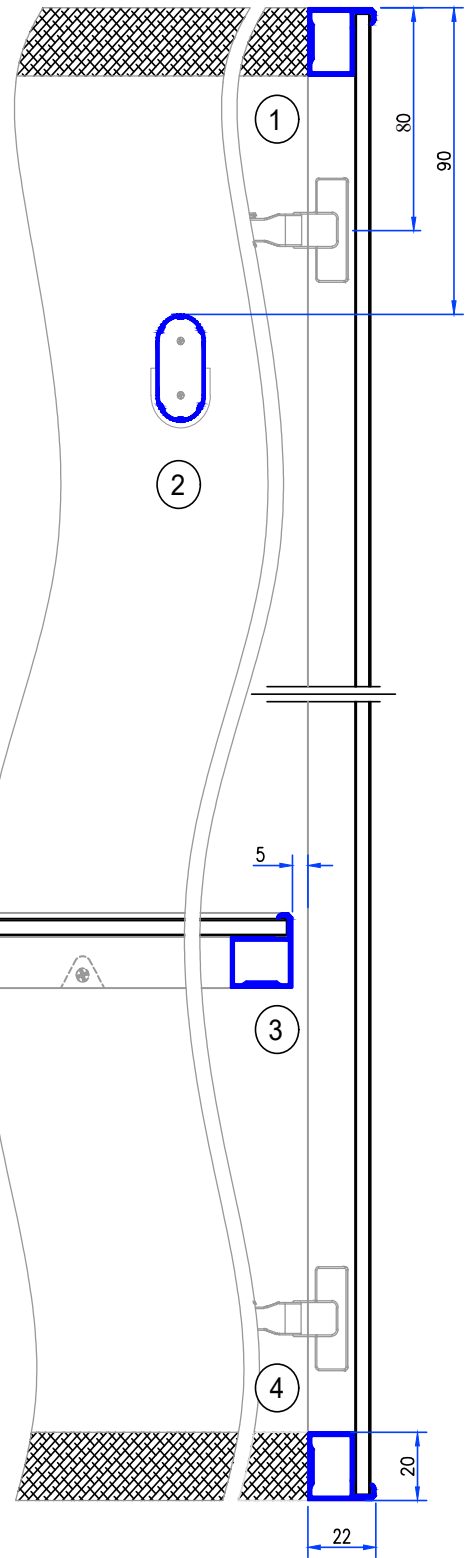
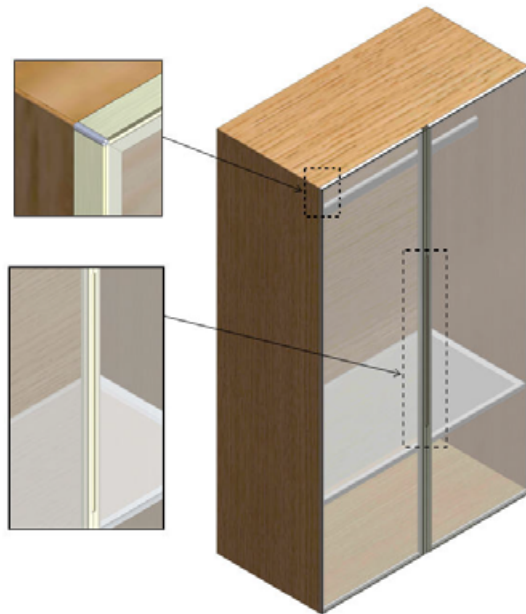
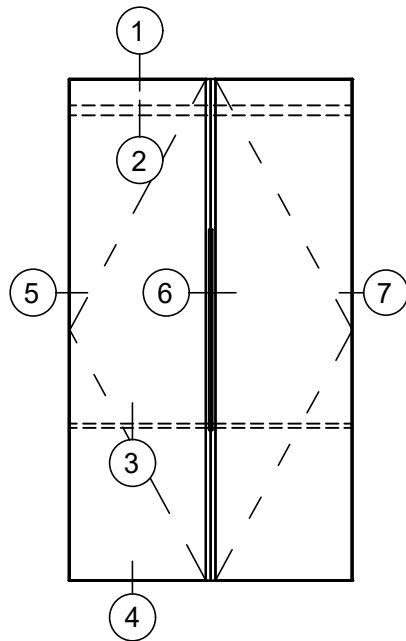

TỦ NHÔM CẢNH KÍNH
FRAME F45

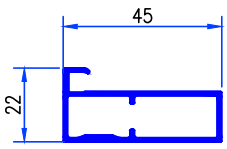

7664

W = 0.483 kg/m
T = 1.3 mm

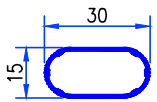

6852

W = 0.208 kg/m
T = 1.0 mm

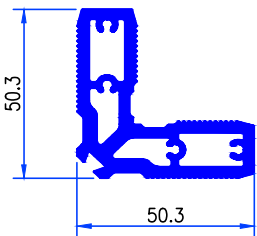

7186

W = 1.982 kg/m
T = 17.0 mm

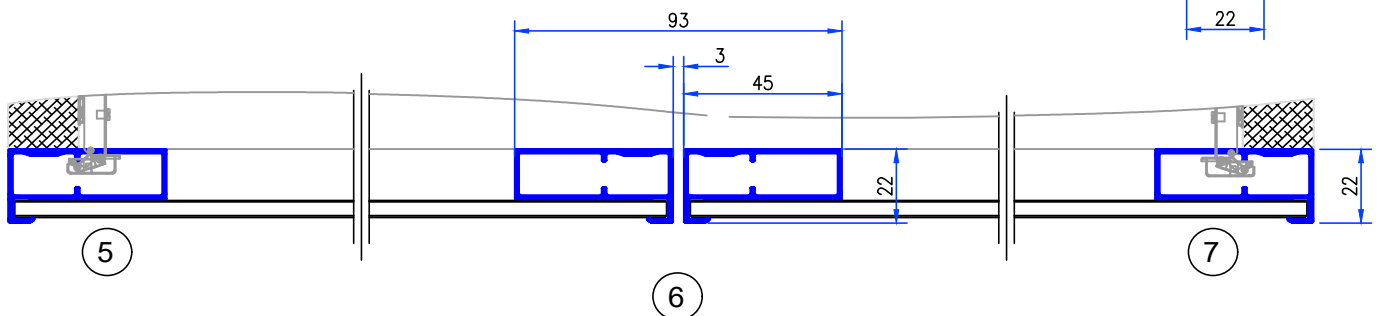
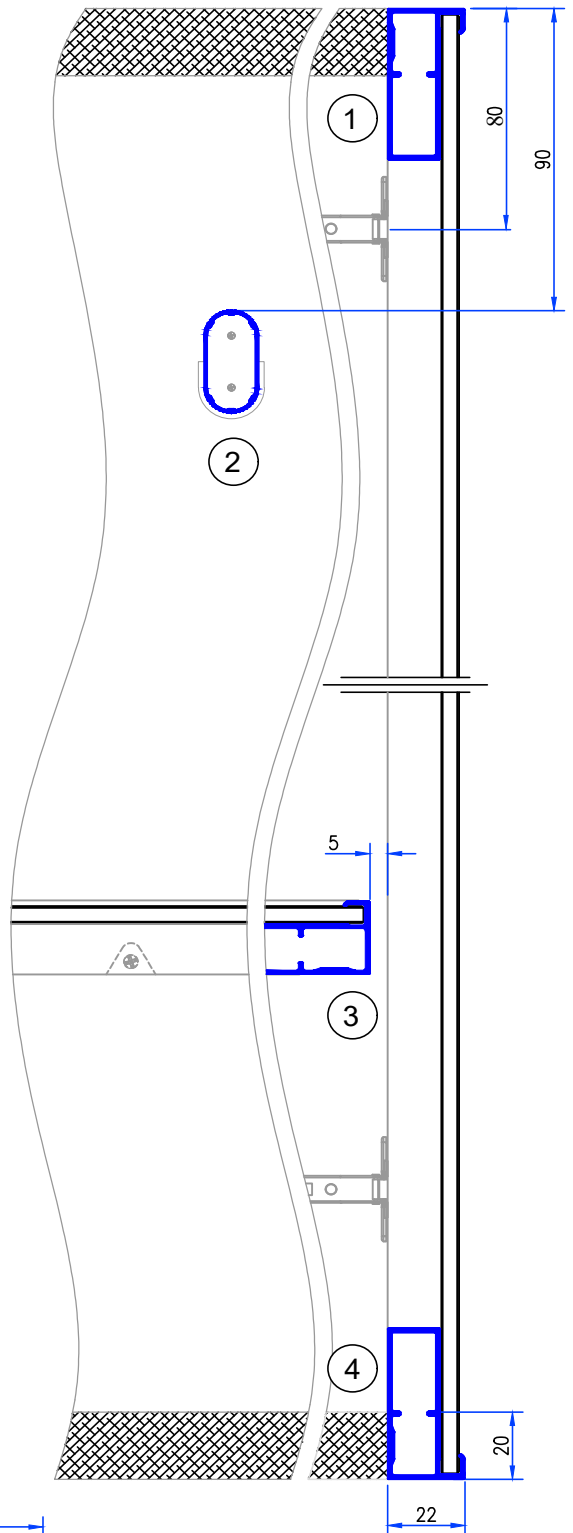
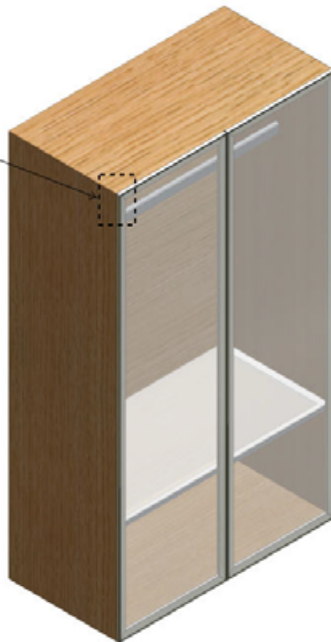
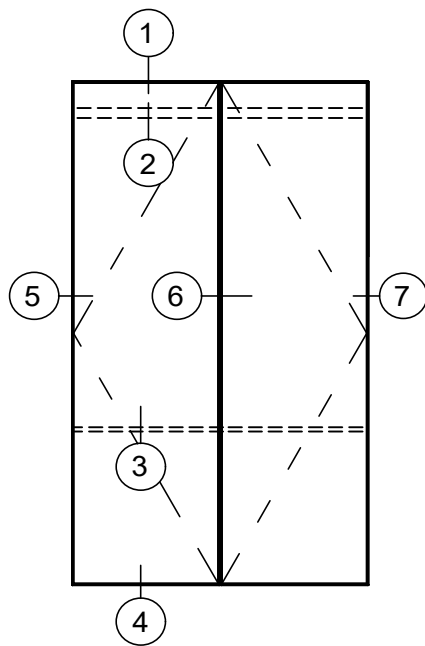

TỦ NHÔM CÁNH KÍNH TAY NẮM CNC
FRAME F45

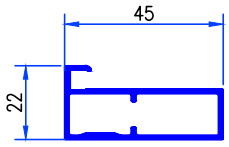

7664

W = 0.483 kg/m
T = 1.3 mm

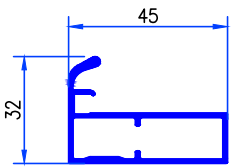

7665

W = 0.561 kg/m
T = 1.3 mm

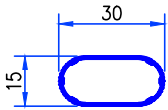

6852

W = 0.208 kg/m
T = 1.0 mm

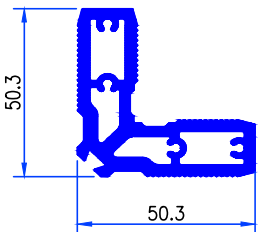

7186

W = 1.982 kg/m
T = 17.0 mm

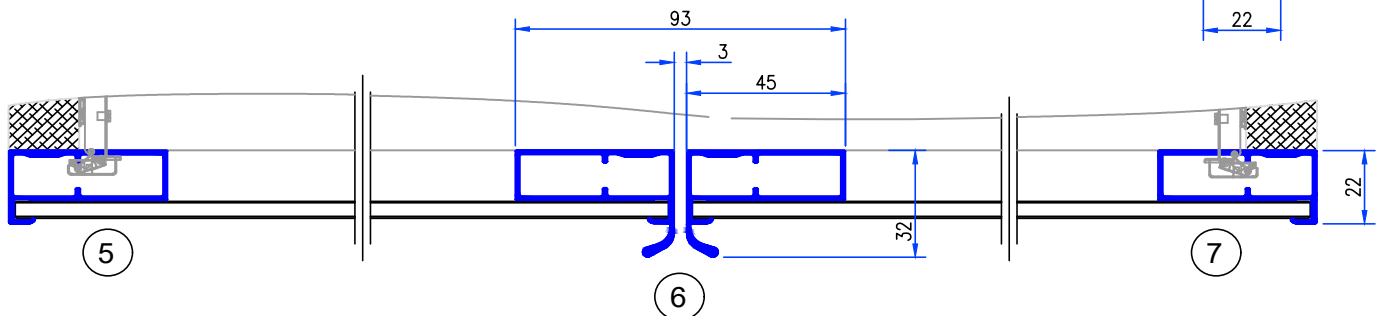
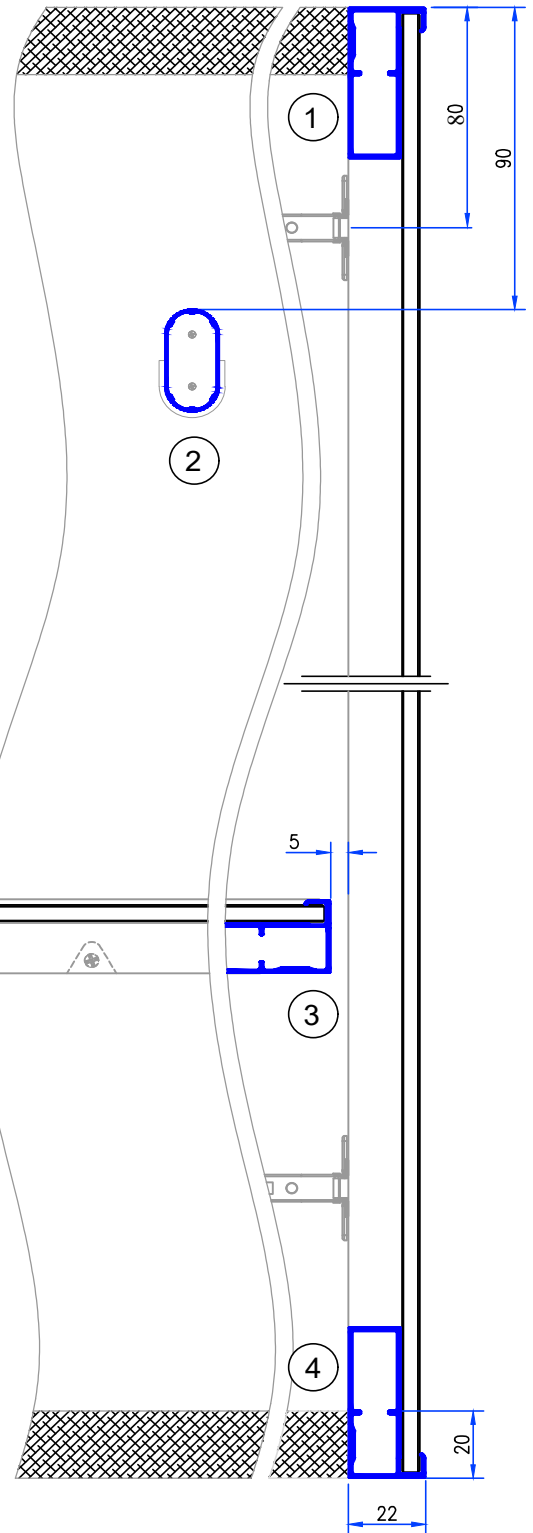
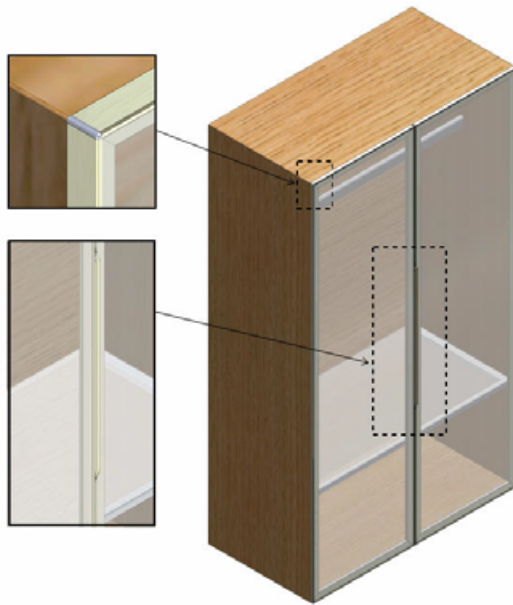
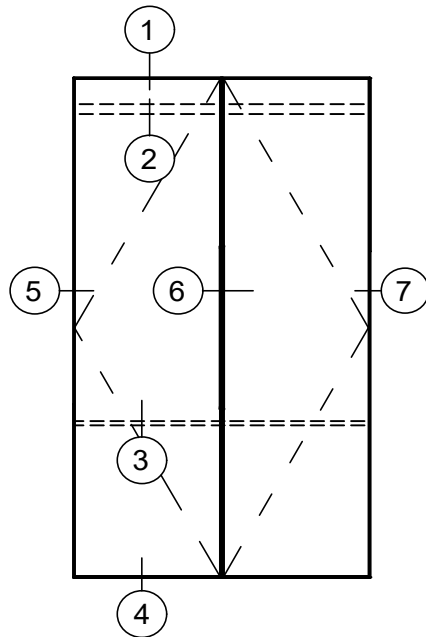

TỦ NHÔM CÁNH KÍNH TAY NẮM ÂM
FRAME F45

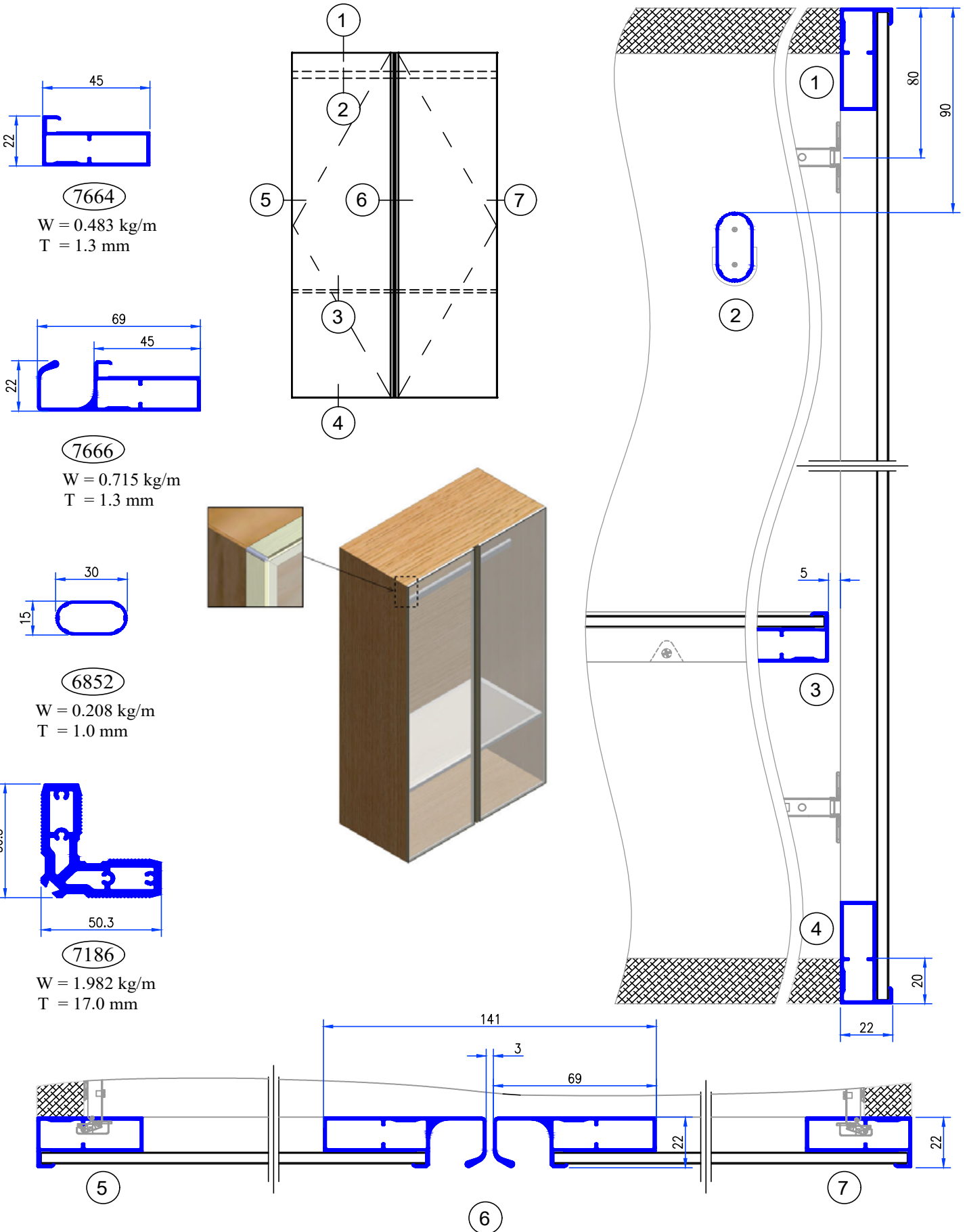

SAPA BEN THANH ALUMINIUM PROFILES CO., LTD.

Add: Lot C, Street No. 3, Binh Chieu IP, Tam Binh Ward, Ho Chi Minh City, Vietnam

Tel: (028) 3896 8780

Email: sales@sapabtg.com - **Website:** www.sapabtg.com